

# LUMIPLUS SPOTLIGHTS AND LAMPS

THE WORLD REFERENT  
IN POOL LIGHTING

Underwater and decorative LED  
lighting solutions for any type  
of pool.



New

Available in 2021

**Stainless steel versions :**

- Full Stainless Steel
- ABS with Stainless Steel embellisher



**ASTRALPOOL** 

AstralPool LumiPlus is the most extensive family in the market of underwater spotlights for public, commercial and residential pools. The entire LumiPlus range is made of high-quality LEDs and electronic components, and is manufactured entirely in the EU to European quality standards.

### The most comprehensive range for all pool types

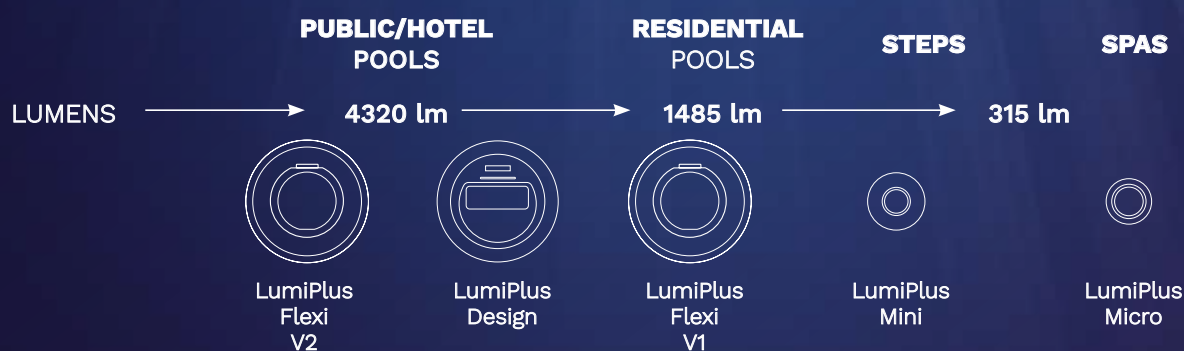

### The LumiPlus family delivers

- Greater energy efficiency.
- High performance spotlights with built-in top quality lighting (TQL) technology.
- Enhanced energy efficiency in a pool thanks to the use of LumiPlus DC lamps and projectors run from a direct current power supply (24 V DC).
- Great control over the range with inclusion of the Internet of Pool (IoP) concept by Fluidra Connect.
- IP68 protection rating.
- L70 50.000 hours lifespan.

# LumiPlus

The world referent in pool lighting.



LumiPlus has a wide range of products so that you can illuminate your pool whenever and however you want.

PROJECTOR

# LumiPlus Flexi

The LED solution that adapts to all types of pool

New



The family of **LumiPlus Flexi** projectors, FlexiNiche, FlexiSlim and FlexiRapid, is characterized by its great adaptability to any type of new-build and existing liner or concrete pool and can be fitted in a niche, on the surface or in a bushing.

Maximum flexibility with the LumiPlus Flexi system by AstralPool.

Ideal for public/hotel pools and residential pools in version V2 and V1, respectively.

### LumiPlus Flexi is made up of 3 components

1



Light chip

2



Niche

3



Faceplate

The 3 components are required for the proper installation of FlexiNiche and FlexiRapid.

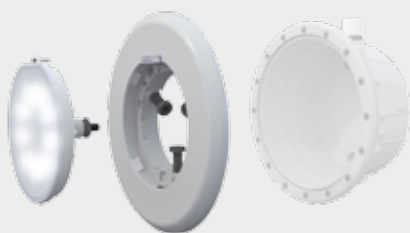

LumiPlus FlexiNiche

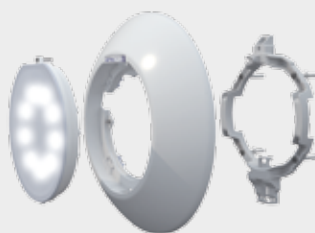

LumiPlus FlexiSlim

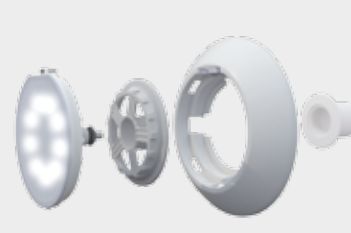

LumiPlus FlexiRapid

# Maximum flexibility for configuring your projector



Power pack supplied with FLEXI DC spotlights

## FlexiNiche projector

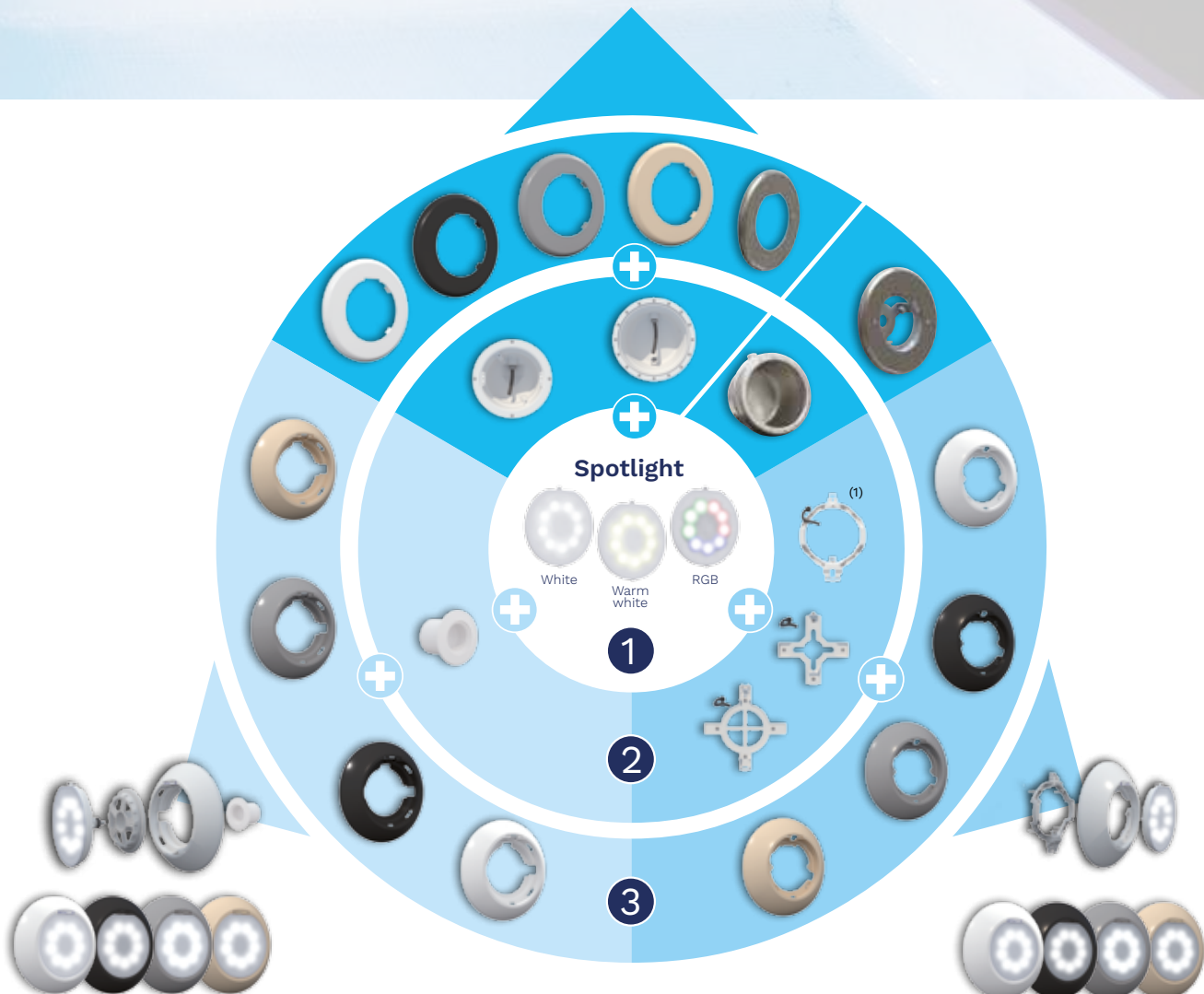

## FlexiRapid projector

## FlexiSlim projector

(1) Included.

# LumiPlus Flexi

The easiest way of illuminating or renewing your pool's lighting.

Compatible with liner and concrete pools.

## Niche

1 Select the color of light	V1 RESIDENTIAL White 1485 lm/RGB 1100 lm		V2 PUBLIC/HOTEL White 4320 lm/RGB 2544 lm		V1 RESIDENTIAL White 1485 lm/RGB	
	<ul style="list-style-type: none"> <li>White 16 W (24VA)</li> <li>Warm white 16 W (24VA)</li> <li>RGB 22 W (29VA)</li> <li>Wireless 22 W (29VA)</li> </ul> <p>V1 - AC (alternating current)</p>	<ul style="list-style-type: none"> <li>White 14 W</li> <li>Warm white 14 W</li> </ul> <p>V1 - DC (direct current)</p>	<ul style="list-style-type: none"> <li>White 32 W (42VA)</li> <li>Warm white 32 W (42VA)</li> <li>RGB 43 W (54VA)</li> <li>RGB-DMX 43 W (54VA)</li> </ul> <p>V2 - AC (alternating current)</p>	<ul style="list-style-type: none"> <li>White 32 W</li> <li>Warm white 32 W</li> </ul> <p>V2 - DC (direct current)</p>	<ul style="list-style-type: none"> <li>White 16 W (24VA)</li> <li>Warm white 16 W (24VA)</li> <li>RGB 22 W (29VA)</li> <li>Wireless 22 W (29VA)</li> </ul> <p>V1 - AC (alternating current)</p>	<ul style="list-style-type: none"> <li>White 14 W</li> <li>Warm white 14 W</li> </ul> <p>V1 (direct)</p>













2 Select a model according to the type of installation	 <p>Ø230 mm models</p>		 <p>Ø180 mm models</p>		 <p>Compatible with for Flat, Extra Flat projectors by</p>

3 Select faceplate colour	 <p>WHITE ANTHRACITE GREY LIGHT GREY BEIGE STAINLESS STEEL</p>					FlexiSlim

 Power pack supplied with FLEXI DC spotlights

## Walls

## Inlet / Bushing

	<b>V2 PUBLIC/HOTEL</b>		<b>V1 RESIDENTIAL</b>		<b>V2 PUBLIC/HOTEL</b>	
1100 lm	White 4320 lm/RGB 2544 lm		White 1485 lm/RGB 1100 lm		White 4320 lm/RGB 2544 lm	
	 White 32 W (42VA)	 Warm white 32 W (42VA)	 White 32 W	 Warm white 32 W	 White 14 W	 Warm white 14 W
	 RGB 43 W (54VA)	 RGB-DMX 43 W (54VA)	 RGB 22 W (29VA)	 Wireless 22 W (29VA)	 RGB 43 W (54VA)	 RGB-DMX 43 W (54VA)
<b>- DC current)</b>	<b>V2 - AC</b> (alternating current)		<b>V1 - AC</b> (alternating current)		<b>V2 - AC</b> (alternating current)	
	<b>V2 - DC</b> (direct current)		<b>V1 - DC</b> (direct current)		<b>V2 - DC</b> (direct current)	

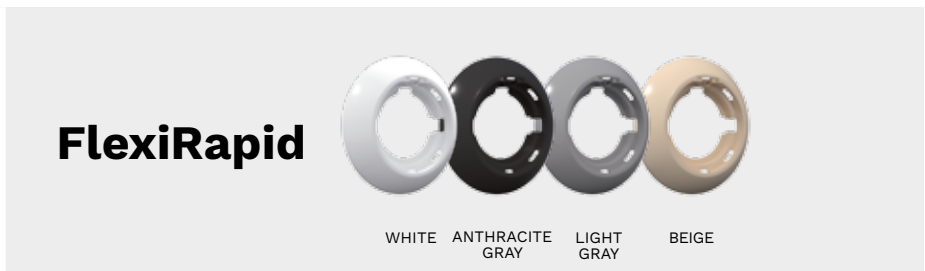
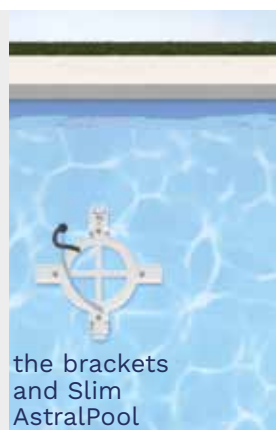

All spotlights come with a 2.5 m power cable.  
Power cables of 5 m, 10 m and 15 m available on request.



Compatible with Fluidra Connect



SPOTLIGHT

# LumiPlus Flexi

Maximum flexibility with the new LumiPlus Flexi system by AstralPool

LumiPlus Flexi lamp

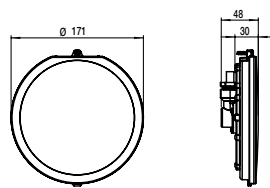

LumiPlus FlexiNiche

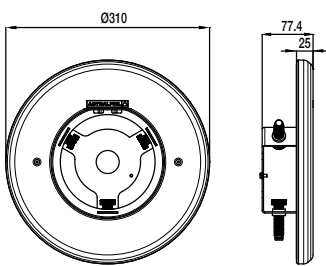

Full stainless Steel

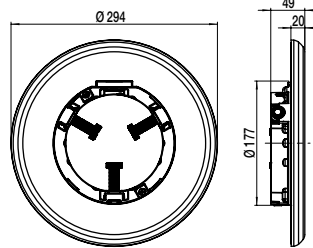

ABS: including ABS with SS embellisher

LumiPlus FlexiSlim

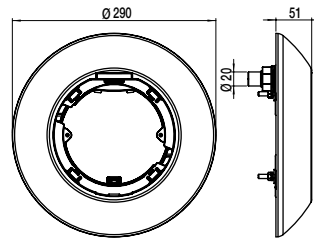

LumiPlus FlexiRapid

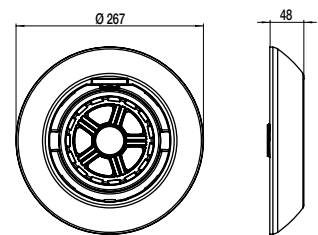

## LumiPlus Flexi LED configurator



<https://www.astralpool.com/configurador-led-lumiplus-flexi/>

## Control systems

The RGB model is compatible with the following control systems: LumiPlus Eco, LumiPlus Top, the LumiPlus LED app and LumiPlus Modbus Fluidra Connect.

## Installation

Scan the QR code and follow the instructions.



LumiPlus FlexiNiche



LumiPlus FlexiSlim



LumiPlus FlexiRapid

**Tips:** To correctly light a pool, it is advisable to install a LumiPlus Flexi V1 for every 20 m<sup>2</sup> of water surface and for every 25 m<sup>2</sup> in the case of the V2 version. The projectors should always be installed completely submerged in water.



# Components required to install a LumiPlus Flexi - choose the components according to your requirements

- New-build pools - FlexiNiche or FlexiRapid: 1+2+3
- New-build pools - FlexiSlim: 1+3
- Replacement without changing niche: 1+3

1 SPOTLIGHT		Code	Code
		V1	V2
	White AC LumiPlus Flexi spotlight	71200	71233
	Warm White AC LumiPlus Flexi spotlight	71200WW	71233WW
	White DC LumiPlus Flexi spotlight	71201	71202
	Warm White DC LumiPlus Flexi spotlight	71201WW	71202WW
	RGB AC LumiPlus Flexi spotlight <sup>(1)</sup>	71203	71204
	Wireless AC LumiPlus Flexi spotlight <sup>(2)</sup>	71205	
	Wireless AC 1 PL LumiPlus Flexi spotlight + 1 Control Motion <sup>(2)</sup>	71206	
	Wireless AC 2 PL LumiPlus Flexi spotlight + 1 Control Motion <sup>(2)</sup>	71207	
	RGB DMX AC LumiPlus Flexi spotlight <sup>(1)</sup>		71208

All spotlights come with a 2.5 m power cable. Power cables of 5 m, 10 m and 15 m available on request.  
<sup>(1)</sup> Choose the most suitable remote control (see control systems section). <sup>(2)</sup> Compatible with ABS trim solutions.

2 NICHE		Code	Code
		Ø180	Ø230
	<b>NICHE*</b>		
	Niche in ABS for concrete pools	59813	00349
	Niche S.S. for concrete pools /prefabricated pools		54102 / 54103
	Niche in ABS for prefabricated pools with inserts	59814	00364 / 17805
	Niche in ABS for prefabricated pools without inserts	59815	28887 / 72261 <sup>(1)</sup>
	<b>RAPID INLET</b>		
	Inlet for concrete pools with 1 1/2" threaded Ø63 PN-6 piping		35418
	Inlet for concrete pools with 1 1/2" threaded Ø63 PN-10 piping		35421
	Inlet for liner prefabricated pools with 1 1/2" thread		27084
	Inlet for polyester prefabricated pools		38805

Other Ø230 and Ø180 niches also available (see catalogue).

For FlexiSlim version installed in concrete + liner pools, Kit 71234 should be used to complete installation (not delivered with).

\* Suitable to use ABS niches with ABS trim Flexi solutions <sup>(1)</sup> Parker screws.

3 TRIM		Code
	<b>FLEXINICHE</b>	
	White	71209
	Beige	71209CL090
	Light grey	71209CL129
	Anthracite grey	71209CL144
	Stainless steel embellisher with ABS fitting	<b>New</b> 71209CLSS
	Full Stainless Steel	73440
	<b>FLEXISLIM</b>	
	White	71210
	Beige	71210CL090
	Light grey	71210CL129
	<b>FLEXIRAPID</b>	
	White	71211
	Beige	71211CL090
	Light grey	71211CL129
	Anthracite grey	71211CL144

KITS : FACEPLATE + SPOTLIGHT		Code	Code
		WHITE AC	WHITE DC
	FlexiNiche: White faceplate + white spotlight	71212	71213
	FlexiSlim: White faceplate + white spotlight	71214	71215
	FlexiRapid: White faceplate + white spotlight	71216	71217
	Kit FlexiNiche White + Vulcanized Kit (to convert from halogen to LED)*	71212K	
	FlexiNiche : Full SS Projector body + white spotlight	<b>New</b> 73442	73441

AC - Alternating current DC - Direct current \* The 2 components of the kit are delivered separately

SPOTLIGHT

# LumiPlus Design

A perfect finish





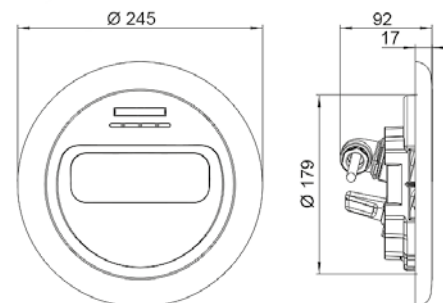

Available in two finishes, pure white or stainless steel effect, its design blends in perfectly with any pool environment.

LumiPlus Design spotlights are set at an angle of 14° to better light up a pool floor and reduce outdoor light pollution.

LumiPlus Design spotlights improve luminous efficacy (lm/W) by around 40% in comparison with the main LED solutions in the market.



Faceplate	WHITE 		RGB  		RGB DMX 	
	White	Stainless steel effect	White	Stainless steel effect	White	Stainless steel effect
Code	59807	59805	59803	59801	59811	59809
Consumption	45 W (50 VA)		40 W (55 VA)		40 W (55 VA)	
Luminous flux	4320 lm		2544 lm		2544 lm	

Also available in: **Warm White**

**Tips:** To correctly light a pool it is advisable to install a lamp from the LumiPlus range for every 25 m<sup>2</sup> of water surface.

The spotlights are not supplied with a niche, so a suitable niche must be selected for full spotlight assembly. The spotlights should always be installed completely submerged in water. The spotlight is not supplied with a niche. Only compatible with a Ø180 mm niche.

### Control systems

The RGB model is compatible with the following control systems: LumiPlus Eco, the LumiPlus LED app, LumiPlus Modbus Fluidra Connect and LumiPlus TOP.

\*Resistant to salt water.

# LumiPlus PAR56

The efficient solution for upgrading your pool to LED lighting



 Power pack supplied with PAR 56 DC spotlights and white lamps.





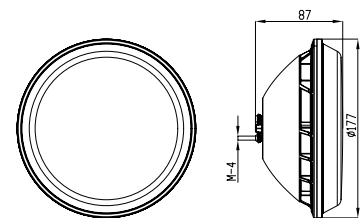

LumiPlus lamps deliver a lighting performance up to three times higher and greater energy efficiency than those currently available in the market.

Their enhanced luminous flux and optical efficiency will bring out the best in any facility.

Thanks to their technology, light can be evenly distributed across a pool. LED white light lamps are ideal for replacing PAR56 300 W halogen lamps as they save over 90% in power consumption and have a service life of up to 100 times longer than a PAR56 halogen lamp.



\* DC model measurements

	WHITE - DC		RGB	
Version	V1 	V2 	V1 	V2 
Code	67515	67516	56001	43411
Consumption	14 W	32 W	27 W (37 VA)	48 W (64 VA)
Luminous flux	1485 lm	4320 lm	1100 lm	2544 lm
Also available in:	Warm White			

### How to change your lamp?

Scan the QR code and follow the instructions.



### Control systems

The RGB model is compatible with the following control systems: LumiPlus Eco, the LumiPlus LED app, LumiPlus Modbus Fluidra Connect and LumiPlus TOP.

**Tips:** To correctly light a pool it is advisable to install a LumiPlus PAR56 V1 for every 20 m<sup>2</sup> of water surface and for every 25 m<sup>2</sup> in the case of the V2 version. The lamps do not include a cable. Must always be submerged in water.

\*Resistant to salt water.

SPOTLIGHT

# LumiPlus Mini and Micro

Ideal for small spaces



\*Color front plate available for Mini V2.

New range of mini and micro LED spotlights with greater light intensity, of higher quality and better energy efficiency.

Their design now makes for a more seamless fit in pools and they are easier to install than ever before.

Suitable for installation in steps, bushings, niches and spas.



Light	MINI V3 – MINI V2*				MICRO			
	WHITE		RGB		WHITE		RGB	
Faceplate	White	Stainless steel	White	Stainless steel	White	Stainless steel	White	Stainless steel
Consumption	4 W (6 VA)		4 W (7 VA)		6 W (9 VA)		4 W (7 VA)	
Luminous flux	315 lm		186 lm		315 lm		186 lm	

The faceplate for Mini V3 spotlights is in a stainless steel effect.  
Stainless steel faceplates for Mini V2 and Micro spotlights are AISI-316 quality.

### Control systems

The RGB model is compatible with the following control systems: LumiPlus Eco, the LumiPlus LED app, LumiPlus Modbus Fluidra Connect and LumiPlus TOP.

# LumiPlus Control systems

SYSTEM		CODE	DESCRIPTION	PROJECTOR
LumiPlus RGB ECO		32458	<p><b>The simplest and most economical colour change system.</b></p> <p>LumiPlus ECO is a push-button switch that allows 14 modes of operation: 7 fixed colours and 7 different colour sequences.</p> <p>Each time the push button is pressed, the colour or sequence will change. By pressing for several seconds, the light is white.</p> <p>The push button must be sized to withstand the power consumed by the number of lights in the facility.</p> <p>Maximum charge 700 VA. Must be connected in the transformer primary.</p>	Any LumiPlus RGB projector
LumiPlus WIRELESS	LumiPlus Motion Control	59125	<p><b>Colour change CONTROL in your hand.</b></p> <p>The LumiPlus Control Motion remote control enables wireless projector control, directly offering on/off options, 12 colour changes, 8 sequence changes and sequence speed.</p> <p>It also detects movement, letting you activate colours and sequences by vertical and horizontal movements, respectively.</p> <p>Compatible with the LumiPlus Wireless range of projectors only.</p> <p>Can control 2 wireless projectors.</p>	Flexi (ABS body) V1 RGB Wireless PAR56 V1 RGB Wireless * Not compatible with stainless steel FlexiNiche projectors.
	LumiPlus Wireless Range Extender	64633	<p>Allows expansion of the signal that the LumiPlus Control Motion sends to the projectors with the wireless control system.</p> <p>Ideal for facilities whose architectural features or projectors installation makes it hard for the LumiPlus Control Motion signal to reach the wireless projectors properly.</p>	
LumiPlus RGB TOP		27818 + 41988	<p><b>The LumiPlus TOP system for the remote control of pool colour changes.</b></p> <p>System comprising the 27818 modulator and 41988 remote control that enables to control a large number of projectors. The modulator has an antenna with a 50m range to receive the signal from the remote control (bought separately).</p> <p>The LumiPlus TOP system enables:</p> <ul style="list-style-type: none"> <li>• Projector on/off action.</li> <li>• Colour selection: 12 fixed colours available.</li> <li>• Sequence selection: 8 sequences available.</li> <li>• Sequence speed selection: 8 speeds available for each sequence.</li> </ul> <p>Supplied separately. A total of 10 LumiPlus modulators can be synchronized.</p>	Any LumiPlus RGB projector

# LumiPlus Control systems

	SYSTEM	CODE	DESCRIPTION	PROJECTOR
LumiPlus LED app LumiPlus Wi-Fi	Existing installation	59131	<p><b>Control your pool lighting from your smartphone.</b></p> <p>App to check LumiPlus lights and projectors from an Android or iOS smartphone or tablet.</p> <p>Enables to control your LumiPlus lights or spotlights from your smartphone or tablet.</p>	Any LumiPlus RGB projector
	New installation	59132	<p>The LumiPlus app should only be installed as an additional feature to the LumiPlus Modulator. It offers a range of 12 colours and 8 sequences or colour change programs.</p> <p>Free app you can download directly from the following sites:</p> <p>Apple: <a href="http://www.lumiplusled-ios.astralpool.com">www.lumiplusled-ios.astralpool.com</a> Android: <a href="http://www.lumiplusled-android.astralpool.com">www.lumiplusled-android.astralpool.com</a></p>	







LumiPlus Modbus FLUIDRA CONNECT	Existing installation	57434	<p><b>Control your pool lighting anywhere, anytime.</b></p> <p>The Modbus protocol enables the control of the LumiPlus modulator. It can be used to switch the projectors on and off, change their colours and sequence speed and set the time for putting the projectors in sleep mode.</p>	Any LumiPlus RGB projector
	New installation	57435	<p>Download the Fluidra Connect app for instant information about the state of your pool 365 days a year. Fluidra Direct is peace of mind, comfort and leisure. In addition to controlling projectors, LumiPlus lets you control the filtration, water treatment and more of your pool through the Modbus protocol.</p> <p>The LumiPlus Modbus should only be installed as an additional feature to the LumiPlus 27818 modulator for correct installation and operation.</p>	



## Fluidra Connect

Comprehensive solution for the control of all pool settings wherever you are

# LumiPlus Control systems

SYSTEM		CODE	DESCRIPTION	PROJECTOR
			<b>System to prepare lighting scenes for fountains and large aquatic spaces</b>	
LumiPlus RGB DMX	RGB DMX Modulator	 41107	<p>DMX LED projector modulator/12V AC</p> <ul style="list-style-type: none"> <li>• DMX receiver for the Flexi, PAR56, S-LIM and Design ranges.</li> <li>• Receiving orders from the DMX controller (Astral DMX 74099 or Astral DMX Pro 74500) via the DMX bus and acting on the projectors that are connected.</li> </ul>	LumiPlus RGB-DMX projector
	RGB-DMX power pack	 52142	<p>Product designed exclusively for use with V2 and V3 Mini LED and RGB DMX Micro projectors.</p> <p>The power pack can control up to 9 projectors, receiving orders from the system's DMX controller (Astral DMX 74099 or Astral DMX Pro 74500) via the DMX bus and acting on the projectors that are connected.</p> <p>The power pack has been designed to be used solely with DMX protocol and 24V DC DMX controllable parts from AstralPool.</p>	
	DMX Controller	 <b>New</b> 74099	<p>LumiPlus DMX System makes it possible to control lights individually or by groups.</p> <p>Users will have easy and intuitive full control over a projector or group of projectors.</p> <p>Main advantages / benefits:</p> <ul style="list-style-type: none"> <li>• Very accurate control over the lights: colour and dimming.</li> <li>• Plug and play.</li> <li>• Projectors can be operated independently or combined.</li> </ul>	
	DMX PRO controller	 <b>New</b> 74100	<ul style="list-style-type: none"> <li>• Allows creating new light scenes.</li> <li>• LumiPlus DMX system does not require any additional wiring for projectors.</li> <li>• Smartphone or tablet control via an app.</li> </ul>	

**FLUIDRA**

For further information:

**[www.astralpool.com](http://www.astralpool.com)**

FLUIDRA S.A.

**[www.fluidra.com](http://www.fluidra.com)**